

DK

ADVARSEL
Følgende operationer bør kun udføres på modulet i spændingsløs tilstand og under ESD-sikre forhold. Installation, ledningsmontage og demontage. Fejlfinding på modulet. Reparation af modulet må kun foretages af PR electronics A/S.

ADVARSEL
PR Loop Link programmeringsenheden må ikke benyttes til kommunikation med moduler installeret i Ex-område.
Enhederne skal installeres i henhold til den tilhørende installations vejledning ved montering i eksplosionsfarlig område.

SIKKERHEDSREGLER
Modtagelse og udpakning
Udpak modulet uden at beskadige det. Kontrollér ved modtagelsen, at modtypen svarer til den bestilte. Indpakningen bør følge modulet, indtil dette er monteret på blivende plads.

Miljøforhold
Undgå direkte sollys, kraftigt støv eller varm, mekaniske tryk og stød, og udsæt ikke modulet for regn eller kraftigt fugt. Om nødvendigt skal opstart og demontage foretages i henhold til de lokale forskrifter eller alternativt direkte til PR electronics A/S.

Installation
Modulet må kun tilsluttes af kvalificerede teknikere, som er bekendt med de tekniske udtryk, advarsler og instruktioner i installationsvejledningen og som vil følge disse. Hvis der er tvivl om modulets rette håndtering, skal der rettes henvendelse til den lokale forhandler eller alternativt direkte til PR electronics A/S.
Installation og tilslutning af modulet skal følge landets gældende regler for installation af elektrisk materiel bl.a. med hensyn til ledningsværnsrat, for sikring og placering.
Beskrivelse af indgang / udgang og forsyningsforbindelser findes i produktmanualen, som kan hentes på www.prellectronics.dk.

Kalibrering og justering
Under kalibrering og justering skal måling og tilslutning af eksterne spændinger udføres i henhold til denne installationsvejledning, og teknikeren skal benytte sikkerhedsmæssigt korrekte værktøjer og instrumenter.

Renngøring
Modulet må, i spændingsløs tilstand, rengøres med en klud let fugtet med destilleret vand.

PC-programmering af SYSTEM 5300
Modulet konfigureres til den aktuelle opgave ved hjælp af en PC og PR electronics A/S' kommunikationsinterface Loop Link. Det er muligt at konfigurere modulet både med og uden tilsluttet forsyningsspænding. Idet kommunikationsinterface leverer nødvendig forsyning til opsettningen. Kommunikationsinterface er galvanisk isoleret, så PCens port er optimalt beskyttet. Kommunikationen er 2-vejs, så modulets opsettning kan hentes ind i PC'en, og opsettningen i PC'en kan sendes til modulet. For de brugere der ikke selv vil foretage opsettning, kan modulet leveres konfigureret efter oplyst specifikation: indgangstype, måleområde, følerfejeldetektering og udgangssignal.

Elektriske specifikationer

Specifikationsområde.....	-40°C til +85°C
Forsyningsspænding, 5331A & 5334A.....	7,2..35 VDC
Forsyningseffekt, 5331A & 5334A.....	25 mW..0,8 W
Forsyningsspænding, 5331D & 5334B.....	7,2..30 VDC
Internt effekttab, 5331D & 5334B.....	25 mW..0,7 W
Isolationsspænd., test/drift.....	1,5 kVAC / 50 VAC
Kalibreringstemperatur.....	20..28°C
Relativ fugtighed.....	< 95% RH (ikke kond.)
Mål.....	Ø44 x 20,2 mm
Kapslingsklasse (hus/klemme).....	IP68 / IP00

Indgangstyper

P1100.....	-200°C..+850°C
NI100.....	-60°C..+250°C
TC-indgang.....	B, E, J, K, L, N, R, S, T, U, W3, W5, Lr
Lin. R.....	0 Ω..5000 Ω
Spænding.....	-12..800 mV

Strømodgang

Signalområde.....	4..20 mA
Min. signalamråde.....	15 mA
Belastningsmodstand, Ω.....	≤ (Vforsyn.-7,2V)/0,023

Overholde myndighedskrav

EMC.....	2014/30/EU & UK SI 2016/1091
ATEX.....	2014/34/EU & UK SI 2016/1107
RoHS.....	2011/65/EU & UK SI 2012/3032
EAC.....	TR-CU 020/2011
EAC Ex.....	TR-CU 012/2011

Godkendelser

DNV, Ships & Offshore.....	TAA0000101
EAC Ex.....	RU C-DK.HA65.B.00355/19

UK

WARNING
The following operations should only be carried out on a disconnected device and under ESD safe conditions. General mounting, connection and disconnection of wires. Troubleshooting the device. Repair of the device must be done by PR electronics A/S only.

WARNING
Do not use the Loop Link programming interface to program the units in Ex area. For installation in classified area the modules must be installed according to the appropriate installation drawings.

SAFETY INSTRUCTIONS
Receipt and unpacking
Unpack the device without damaging it. The packing should always follow the device until this has been permanently mounted. Check at the receipt of the device whether the type corresponds to the one ordered.

Environment
Avoid direct sunlight, dust, high temperatures, mechanical vibrations and shock, as well as rain and heavy moisture. If necessary, heating in excess of the stated limits for ambient temperatures should be avoided by way of ventilation.

Mounting
Only qualified technicians who are familiar with the technical terms, warnings, and instructions in this installation guide and who are able to follow these should connect the device. Should there be any doubt as to the correct handling of the device, please contact your local distributor or, alternatively, PR electronics A/S.
Mounting and connection of the device should comply with national legislation for mounting of electric materials, i.e. wire cross section, protective fuse, and location. Descriptions of input / output and supply connections are shown in the product manual found on www.prellectronics.com.

Calibration and adjustment
During calibration and adjustment, the measuring and connection of external voltages must be carried out according to the specifications of this installation guide. The technician must use tools and instruments that are safe to use.

Cleaning
When disconnected, the device may be cleaned with a cloth moistened with distilled water.

PC programming of SYSTEM 5300
The device is configured to the present task by way of a PC and PR electronics A/S' communications interface Loop Link. The device can be configured with or without a connected supply voltage as the communications interface supplies the necessary voltage to the set-up. The communications interface is galvanically isolated to protect the PC port.
Communication is 2-way to allow the retrieval of the device set-up into the PC and to allow the transmission of the PC set-up to the device. For users who do not wish to do the set-up themselves, the device can be delivered configured according to customer specifications: input type, measurement range, sensor error detection, and output signal.

Electrical specifications

Specifications range.....	-40°C to +85°C
Supply voltage, 5331A & 5334A.....	7,2..35 VDC
Internal power dissipation, 5331A & 5334A.....	25 mW..0.8 W
Supply voltage, 5331D & 5334B.....	7,2..30 VDC
Internal power dissipation, 5331D & 5334B.....	25 mW..0.7 W
Isolation voltage, test/oper.....	1.5 kVAC / 50 VAC
Calibration temperature.....	20..28°C
Relative humidity.....	< 95% RH (non-cond.)
Dimensions.....	Ø44 x 20.2 mm
Protection degree (encl./terminal).....	IP68 / IP00

Input types

P1100.....	-200°C..+850°C
NI100.....	-60°C..+250°C
TC input.....	B, E, J, K, L, N, R, S, T, U, W3, W5, Lr
Lin. R.....	0 Ω..5000 Ω
Voltage.....	-12..800 mV

Current output

Signal range.....	4..20 mA
Min. signal range.....	15 mA
Load resistance, Ω.....	≤ (Vsupply-7.2V)/0.023

Observed authority requirements

EMC.....	2014/30/EU & UK SI 2016/1091
ATEX.....	2014/34/EU & UK SI 2016/1107
RoHS.....	2011/65/EU & UK SI 2012/3032
EAC.....	TR-CU 020/2011
EAC Ex.....	TR-CU 012/2011

Approvals

DNV, Ships & Offshore.....	TAA0000101
EAC Ex.....	RU C-DK.HA65.B.00355/19

FR

AVERTISSEMENT
Les opérations suivantes doivent être effectuées avec le module débranché et dans un environnement exempt de décharges électrostatiques (ESD): montage général, raccordement et débranchement de fils et recherche de pannes sur le module. Seule PR electronics SARL est autorisée à réparer le module.

AVERTISSEMENT
Ne pas utiliser le kit de programmation "Loop Link" en zone classée dangereuse Ex. Pour des installations en zone classée, les modules doivent être monté conformément aux plans appropriés.

CONSIGNES DE SECURITE
Réception et déballage
Déballer le module sans l'endommager. Il est recommandé de conserver l'emballage du module tant que ce dernier n'est pas définitivement monté. A la réception du module, vérifiez que le type de module reçu correspond à celui que vous avez commandé.

Environnement
N'exposez pas votre module aux rayons directs du soleil et choisissez un endroit à humidité modérée et à l'abri de la poussière, des températures élevées, des chocs et des vibrations mécaniques et de la pluie. Le cas échéant, des systèmes de ventilation permettent d'éviter qu'une pièce soit chauffée au-delà des limites prescrites pour les températures ambiantes.

Montage
Il est conseillé de réserver le raccordement du module aux techniciens qualifiés qui connaissent les termes techniques, les avertissements et les instructions de ce guide et qui sont capables d'appliquer ces derniers.
Si vous avez un doute quelconque quant à la manipulation du module, veuillez contacter votre distributeur local. Vous pouvez également vous adresser à PR electronics SARL. Le montage et le raccordement du module doivent être conformes à la législation nationale en vigueur pour le montage de matériaux électriques, par exemple, diamètres des fils, fusibles de protection et implantation des modules. Les connexions des alimentations et des entrées / sorties sont décrites dans le manuel du produit sur www.prellectronics.fr.

Etalonnage et réglage
Lors des opérations d'étalonnage et de réglage, il convient d'effectuer les mesures et les connexions des tensions externes en respectant les spécifications mentionnées dans ce guide. Les techniciens doivent utiliser des outils et des instruments pouvant être manipulés en toute sécurité.

Maintenance et entretien
Une fois le module hors tension, prenez un chiffon imbibé d'eau distillée pour le nettoyer.

Programmation par PC du SYSTÈME 5300
Le module peut être programmé en fonction d'une application donnée à partir d'un PC et le kit de programmation Loop Link de PR electronics A/S. Le module peut être programmé sans être alimenté car l'interface de communication fournit l'alimentation nécessaire pour la configuration. L'interface de communication est dotée d'une isolation galvanique pour protéger le port du PC. La communication est bidirectionnelle. Cela permet non seulement la programmation du module mais également la récupération d'une configuration existante ainsi que la lecture du numéro de série et du repère. Le module peut être livré déjà programmé, si l'utilisateur le souhaite.

Spécifications

Plage de température.....	-40°C à +85°C
Tension d'alimentation, 5331A & 5334A.....	7,2..35 Vcc
Puissance dissipée, 5331A & 5334A.....	25 mW..0,8 W
Tension d'alimentation, 5331D & 5334B.....	7,2..30 Vcc
Puissance dissipée, 5331D & 5334B.....	25 mW..0,7 W
Calibration température.....	20..28°C
Tension d'iso. test/opér.....	1,5 kVca / 50 Vca
Température d'étalonnage.....	20..28°C
Humidité relative.....	< 95% HR (sans cond.)
Dimensions.....	Ø44 x 20,2 mm
Degré de protection (boîtier/boîrier).....	IP68 / IP00

Types d'entrée

P1100.....	-200°C..+850°C
NI100.....	-60°C..+250°C
Entrée TC.....	B, E, J, K, L, N, R, S, T, U, W3, W5, Lr
Lin. R.....	0 Ω..5000 Ω
Voltage.....	-12..800 mV

Sortie courant

Gamme de signal.....	4..20 mA
Plage de signal min.....	15 mA
Résistance de charge, Ω.....	≤ (Valm.-7.2V)/0,023

Compatibilité avec les normes

CEM.....	2014/30/UE & UK SI 2016/1091
ATEX.....	2014/34/UE & UK SI 2016/1107
RoHS.....	2011/65/UE & UK SI 2012/3032
EAC.....	TR-CU 020/2011
EAC Ex.....	TR-CU 012/2011

Approvals

DNV, Ships & Offshore.....	TAA0000101
EAC Ex.....	RU C-DK.HA65.B.00355/19

DE

WARNUNG
Folgende Maßnahmen sollten nur in spannungslosem Zustand des Gerätes und unter ESD-sicheren Verhältnissen durchgeführt werden: Installation, Montage und Demontage von Leitungen. Fehlersuche im Gerät und Reparaturen des Gerätes dürfen nur von PR electronics A/S vorgenommen werden.

WARNUNG
Benutzen Sie die Programmierschnittstelle Loop Link nicht im Ex Bereich. Zur Montage in klassifizierten Zonen müssen die Geräte nach den dazugehörigen Einbauezeichnungen installiert werden.

SICHERHEITSGELEN
Empfang und Auspacken
Packen Sie das Gerät aus, ohne es zu beschädigen, und kontrollieren Sie beim Empfang, ob der Gerätetyp Ihrer Bestellung entspricht. Die Verpackung sollte beim Gerät bleiben, bis dieses am endgültigen Platz montiert ist.

Umgebungsbedingungen
Direkte Sonneneinstrahlung, starke Staubeentwicklung oder Hitze, mechanische Erschütterungen und Stöße sind zu vermeiden das Gerät darf nicht Regen oder starker Feuchtigkeit ausgesetzt werden. Bei Bedarf muss eine Erwärmung, welche die angegebenen Grenzen für die Umgebungstemperatur überschreitet, mit Hilfe eines Kühlgebläses verhindert werden.

Installation
Das Gerät darf nur von qualifizierten Technikern angeschlossen werden, die mit den technischen Ausdrücken, Warnungen und Anweisungen in dieser Installationsanleitung vertraut sind und diese befolgen.
Sollten Zweifel bezüglich der richtigen Handhabung des Gerätes bestehen, sollte man mit dem Händler vor Ort Kontakt aufnehmen. Sie können aber auch direkt mit PR electronics GmbH Kontakt aufnehmen.
Die Installation und der Anschluss des Gerätes haben in Übereinstimmung mit den geltenden Regeln des jeweiligen Landes bez. der Installation elektrischer Apparaturen zu erfolgen, u.a. bezüglich Leitungsquerschnitt, (elektrischer) Vor-Absicherung und Positionierung.
Eine Beschreibung von Eingangs- / Ausgangs- und Versorgungsanschlüssen befindet sich im Produkthandbuch, das unter www.prellectronics.de gefunden und abgerufen werden kann.

Kalibrering und Justierung
Während der Kalibrering und Justierung sind die Messung und der Anschluss externer Spannungen entsprechend dieser Installationsanleitung auszuführen, und der Techniker muss hierbei sicherheitsmäßig einwandfreie Werkzeuge und Instrumente benutzen.

Reinigung
Das Gerät darf in spannungslosem Zustand mit einem Lappen gereinigt werden, der mit destilliertem Wasser leicht angefeuchtet ist.

PC-Programmierung des Systems 5300
Das Gerät wird für die jeweilige Aufgabe mit Hilfe eines PCs und PR electronics A/S Kommunikationsschnittstelle Loop Link konfiguriert. Es ist möglich, das Gerät sowohl mit als auch ohne angeschlossene Versorgungsspannung zu konfigurieren, da die Kommunikationsschnittstelle die notwendige Versorgung für die Einstellung liefert. Die Kommunikationsschnittstelle ist galvanisch isoliert, sodass der Anschluss des PCs optimal geschützt ist.
Die Kommunikation erfolgt in beiden Richtungen, sodass die Einstellung des Gerätes in den PC geholt, und die Einstellung im PC an das Gerät gesandt werden kann. Für diejenigen Anwender, welche die Einstellung nicht selbst vornehmen wollen, kann das Gerät nach folgenden Kundenspezifikationen konfiguriert geliefert werden: Eingangstyp, Messbereich, Fehlererkennung und Ausgangssignal.

Elektrische Daten

Spezifikationsbereich.....	-40°C bis +85°C
Versorgungsspannung, 5331A & 5334A.....	7,2..35 VDC
Verlustleistung, 5331A & 5334A.....	25 mW..0,8 W
Versorgungsspannung, 5331D & 5334B.....	7,2..30 VDC
Verlustleistung, 5331D & 5334B.....	25 mW..0,7 W
Isolationsspannung, Test / Betrieb.....	1,5 kVAC / 50 VAC
Kalibreringstemperatur.....	20..28°C
Luftfeuchtigkeit.....	< 95% RF (nicht kond.)
Maß.....	Ø44 x 20,2 mm
Schutzart (Gehäuse/Anschl.).....	IP68 / IP00

Eingangstypen

P1100.....	-200°C..+850°C
NI100.....	-60°C..+250°C
TE-Eingang.....	B, E, J, K, L, N, R, S, T, U, W3, W5, Lr
Lin. R.....	0 Ω..5000 Ω
Spannung.....	-12..800 mV

Stromausgang

Signalbereich.....	4..20 mA
Min. Signalbereich.....	15 mA
Belastungswiderstand, Ω.....	≤ (VVersorg.-7.2V)/0,023

Eingehaltene Behördenvorschriften

EMV.....	2014/30/EU & UK SI 2016/1091
ATEX.....	2014/34/EU & UK SI 2016/1107
RoHS.....	2011/65/EU & UK SI 2012/3032
EAC.....	TR-CU 020/2011
EAC Ex.....	TR-CU 012/2011

Zulassungen

DNV, Ships & Offshore.....	TAA0000101
EAC Ex.....	RU C-DK.HA65.B.00355/19

5331A, 5331D, 5334A & 5334B

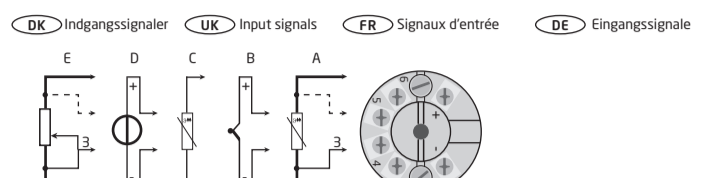

	DK	UK	FR	DE	5331	5334
A RTD	RTD	RTD	RTD	WTH	x	
B TC	TC	TC	TC	TE	x	x
C CJC	CJC	CJC	CSF	CJC	x	x
D Spænding	Voltage	Tension	Spannung		x	x
E Lin R	Lin R	Lin R	Lin R		x	x

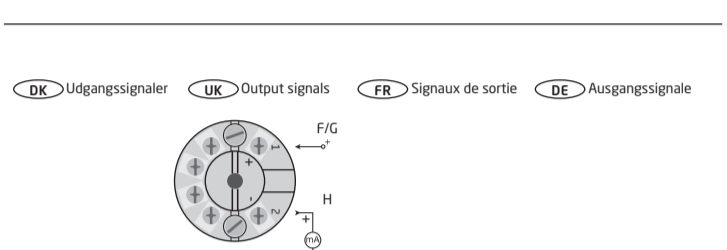

	DK	UK	FR	DE	5331A	5331D	5334A	5334B
F Forsyning +7,2..35 VDC	Supply +7,2..35 VDC	Alimentation +7,2..35 Vcc	Versorgung +7,2..35 VDC		x		x	
G Forsyning +7,2..30 VDC	Supply +7,2..30 VDC	Alimentation +7,2..30 Vcc	Versorgung +7,2..30 VDC			x		x
H 4..20 mA udgang	4..20 mA output	Sortie 4..20 mA	4..20 mA-Ausgang		x	x	x	x

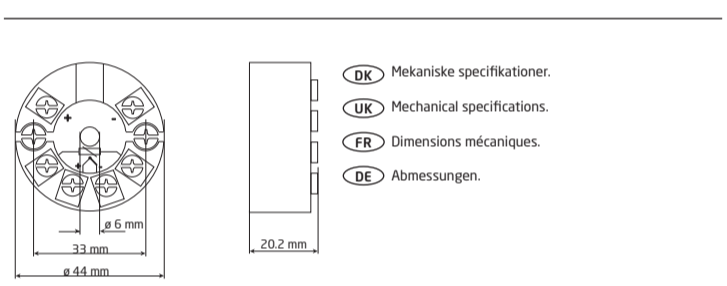
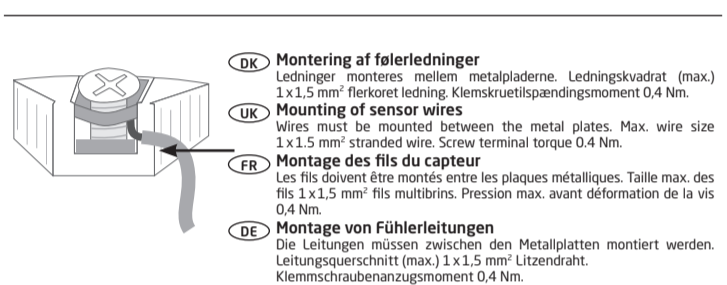

- DK** Dokumentation, godkendelser og yderligere information findes på internettet på www.prellectronics.dk
- UK** Documentation, permits and other information can be found on the internet at www.prellectronics.com
- FR** La documentation et toute autre information peuvent être trouvées sur l'Internet sur notre site: www.prellectronics.fr
- DE** Dokumentationen, Zulassungen und andere Informationen können auf unserer Internet-Seite unter www.prellectronics.de gefunden und abgerufen werden.
- BR** Documentações, licenças e outras informações podem ser encontradas no site www.prellectronics.com

DK Godkendelser UK Approvals FR Approbations DE Zulassungen BR Aprovações

	ATEX	Area / Zone	Installation drawing	IECEx	Area / Zone	Installation drawing	FM	Zone / Div.	Installation drawing	CSA	Zone / Div.	Installation drawing	INMETRO	Area	Installation drawing
5331A	DEKRA 20ATEX0096 X	2, 22	5331QA02	DEK 20.0059X	2, 22	5331QI02			1125003	2 / Div 2	5331QC02	DEKRA 23.0009X	2, 22	5331QB02	
5334A	DEKRA 20ATEX0096 X	2, 22	5331QA02	DEK 20.0059X	2, 22	5331QI02			1125003	2 / Div 2	5331QC02	DEKRA 23.0009X	2, 22	5331QB02	
5331D	DEKRA 20ATEX0095 X	0, 1, 2, 21, 22, M1	5331QA01	DEK 20.0059X	0, 1, 2, 21, 22, M	5331QI01	FM17US0013X	0, 1, 2 / Div 1, 2	5300Q502	1125003	0, 1, 2 / Div 1, 2	533XQC03	DEKRA 23.0009X	0, 1, 2, 21, 22, M	5331QB01
5334B	DEKRA 20ATEX0095 X	0, 1, 2, 21, 22, M1	5331QA01	DEK 20.0059X	0, 1, 2, 21, 22, M	5331QI01						DEKRA 23.0009X	0, 1, 2, 21, 22, M	5331QB01	

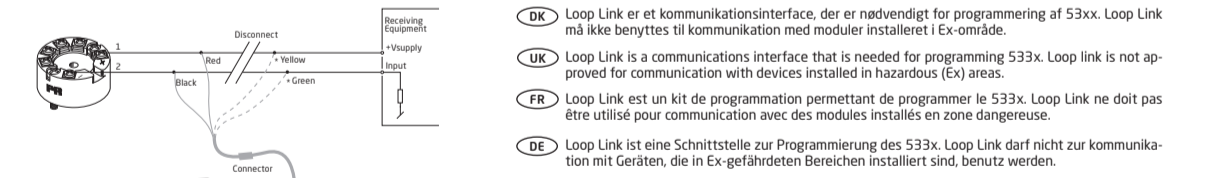

- DK** Loop Link er et kommunikationsinterface, der er nødvendigt for programmering af 53xx. Loop Link må ikke benyttes til kommunikation med moduler installeret i Ex-område.
- UK** Loop Link is a communications interface that is needed for programming 53xx. Loop link is not approved for communication with devices installed in hazardous (Ex) areas.
- FR** Loop Link est un kit de programmation permettant de programmer le 53xx. Loop Link ne doit pas être utilisé pour communication avec des modules installés en zone dangereuse.
- DE** Loop Link ist eine Schnittstelle zur Programmierung des 53xx. Loop Link darf nicht zur Kommunikation mit Geräten, die in Ex-gefährdeten Bereichen installiert sind, benutzt werden.

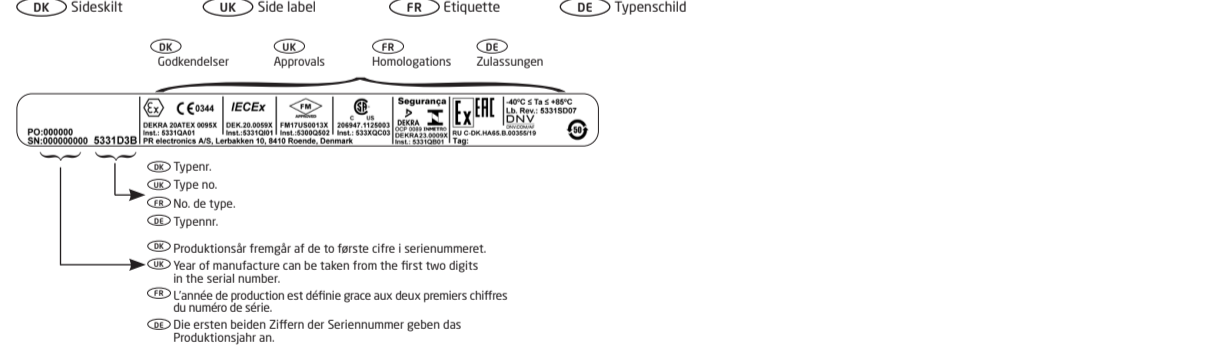

EU DECLARATION OF CONFORMITY
(5331_5334DoC_106)

As manufacturer **PR electronics A/S, Lerbakken 10, DK-8410 Rønde** hereby declares that the following products:
Type: 5331 / 5334
Name: 2-wire programmable transmitter
From serial no.: 212002194 / 212022169
 is in conformity with the following directives and standards:
 The EMC Directive 2014/30/EU and later amendments
 EN 61326-1:2013
 Immunity test requirements for equipment intended to be used in an industrial electromagnetic environment. For specification of the acceptable EMC performance level, refer to the electrical specifications for the device.
 The ATEX Directive 2014/34/EU and later amendments
 EN IEC 60079-0:2018, EN 60079-7:2015 + A1

ATEX-installation drawing 5331QA01-V3R0

For safe installation of 5331D or 5334B the following must be observed. The module shall only be installed by qualified personnel who are familiar with the national and international laws, directives and standards that apply to this area. Year of manufacture can be taken from the first two digits in the serial number.

ATEX Certificate DEKRA 20ATEX0095 X
 Marking II 1 G Ex ia IIC T6...T4 Ga
 II 2 D Ex ia IIIC Db
 I M1 Ex ia I Ma
 Standards EN 60079-0: 2018, EN 60079-11: 2012

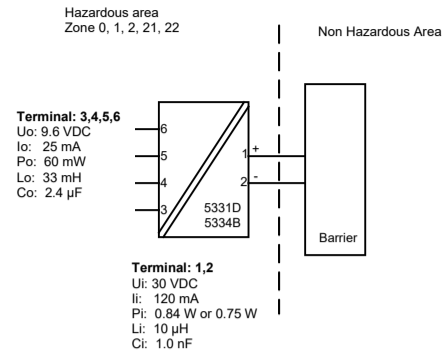

Temperature Class	Ambient temperature range	
	PI: 0,84 W	PI: 0,75 W
T6	-40°C to +47°C	-40°C to +50°C
T5	-40°C to +62°C	-40°C to +65°C
T4	-40°C to +85°C	-40°C to +85°C

Installation notes

If the enclosure is made of non-metallic plastic materials, electrostatic charges on the transmitter enclosure shall be avoided.

If the transmitter is installed in an explosive atmosphere requiring the use of equipment protection level Ga, the transmitter shall be mounted in an enclosure that provides a degree of protection of at least IP20 according to EN 60529, and that is suitable for the application and correctly installed.

If the transmitter is installed in an explosive atmosphere requiring the use of equipment protection level Ga or Ma, and if the enclosure is made of aluminum, it must be installed such that ignition sources due to impact and friction sparks are excluded.

If the transmitter is installed in an explosive atmosphere requiring the use of equipment protection level Db, the transmitter shall be mounted in a separately certified enclosure that provides a degree of protection of at least IP5X according to EN 60079-0, and that is suitable for the application and correctly installed. The surface temperature of the outer enclosure is +20 K above the ambient temperature, determined without a dust layer. Ambient temperature range: -40°C to +85°C.

If the transmitter is installed in an explosive atmosphere requiring the use of equipment protection level Ma, the transmitter shall be mounted in an enclosure that provides a degree of protection of at least IP54 according to EN 60529, and that is suitable for the application and correctly installed. Ambient temperature range: -40°C to +85°C.

Cable entries and blanking elements shall be used that are suitable for the application and correctly installed.

For an ambient temperature ≥ 60°C, heat resistant cables shall be used with a rating of at least 20 K above the ambient temperature.

The sensor circuit is not infallibly galvanically isolated from the input circuit. However, the galvanic isolation between the circuits is capable of withstanding a test voltage of 500 VAC for 1 minute.

ATEX-installation drawing 5331QA02-V3R0

For safe installation of 5331A or 5334A the following must be observed. The module shall only be installed by qualified personnel who are familiar with the national and international laws, directives and standards that apply to this area. Year of manufacture can be taken from the first two digits in the serial number.

ATEX Certificate DEKRA 20ATEX0096 X
 Marking II 3 G Ex na [c] IIC T6...T4 Gc
 II 3 G Ex ec [c] IIC T6...T4 Gc
 II 3 D Ex ic IIIC Dc
 Standards EN 60079-0: 2018, EN 60079-11: 2012, EN 60079-15: 2010, EN 60079-7:2015 +A1: 2018

Terminal 3,4,5,6	Terminal 1,2	Terminal 1,2	Terminal 1,2
Ex ic IIC, Ex ic IIIC	Ex ic IIC, Ex ic IIIC	Ex ic IIC, Ex ic IIIC	Ex na, Ex ec
Uo: 9,6 V Io: 25 mA Po: 60 mW Lc: 33 mH Co: 2,4 µF	Ui = 35 V Ii = 110 mA Ci = 1 nF Li = 10 µH	Ui = 24 V Ii = 260 mA Ci = 1 nF Li = 10 µH	Umax ≤ 35 VDC or Umax ≤ 24 VDC

Ex ic IIC, Ex ic IIIC Temperature Class	Ambient temperature range	
	Ui=35 V	Ui=24 V
T6	-40°C to +54°C	-40°C to +63°C
T5	-40°C to +69°C	-40°C to +78°C
T4	-40°C to +85°C	-40°C to +85°C

Ex ec, Ex na Temperature Class	Ambient temperature range	
	Vmax=35 V	Vmax=24 V
T6	-40°C to +43°C	-40°C to +55°C
T5	-40°C to +85°C	-40°C to +85°C
T4	-40°C to +85°C	-40°C to +85°C

Installation notes

If the enclosure is made of non-metallic plastic materials, electrostatic charges on the transmitter enclosure shall be avoided.

If the transmitter is installed in an explosive atmosphere requiring the use of equipment protection level Gc and applied in type of protection Ex ic, the transmitter shall be mounted in an enclosure that provides a degree of protection of at least IP20 according to EN 60529, and that is suitable for the application and correctly installed.

If the transmitter is installed in an explosive atmosphere requiring the use of equipment protection level Dc, the transmitter shall be mounted in a separately certified enclosure that provides a degree of protection of at least IP5X according to EN 60079-0, and that is suitable for the application and correctly installed. The surface temperature of the outer enclosure is +20 K above the ambient temperature, determined without a dust layer. Ambient temperature range: -40°C to +85°C.

If the transmitter is installed in an explosive atmosphere requiring the use of equipment protection level Gc and applied in type of protection Ex na or Ex ec, the transmitter shall be mounted in a separately certified enclosure that provides a degree of protection of at least IP54 according to EN 60079-0, and that is suitable for the application and correctly installed.

If the transmitter is installed in an explosive atmosphere requiring the use of equipment protection level Gc and applied in type of protection Ex na or Ex ec, the equipment shall only be used in an area of not more than pollution degree 2, as defined in EN 60664-1.

IECEx-installation drawing 5331QI01-V2R0

For safe installation of 5331D or 5334B the following must be observed. The module shall only be installed by qualified personnel who are familiar with the national and international laws, directives and standards that apply to this area. Year of manufacture can be taken from the first two digits in the serial number.

Certificate IECEx DEK 20.0059X
 Marking Ex ia IIC T6...T4 Ga
 Ex ia IIIC Db
 Ex ia I Ma
 Standards IEC 60079-0: 2017, IEC 60079-11: 2011

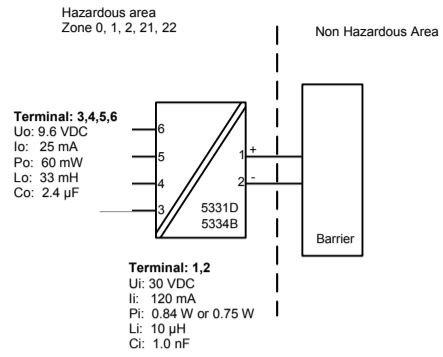

Temperature Class	Ambient temperature range	
	PI: 0,84 W	PI: 0,75 W
T6	-40°C to +47°C	-40°C to +50°C
T5	-40°C to +62°C	-40°C to +65°C
T4	-40°C to +85°C	-40°C to +85°C

Installation notes

If the enclosure is made of non-metallic plastic materials, electrostatic charges on the transmitter enclosure shall be avoided.

If the transmitter is installed in an explosive atmosphere requiring the use of equipment protection level Ga, the transmitter shall be mounted in an enclosure that provides a degree of protection of at least IP20 according to IEC 60529, and that is suitable for the application and correctly installed.

If the transmitter is installed in an explosive atmosphere requiring the use of equipment protection level Ga or Ma, and if the enclosure is made of aluminum, it must be installed such that ignition sources due to impact and friction sparks are excluded.

If the transmitter is installed in an explosive atmosphere requiring the use of equipment protection level Db, the transmitter shall be mounted in a separately certified enclosure that provides a degree of protection of at least IP5X according to IEC 60079-0, and that is suitable for the application and correctly installed. The surface temperature of the outer enclosure is +20 K above the ambient temperature, determined without a dust layer. Ambient temperature range: -40°C to +85°C.

If the transmitter is installed in an explosive atmosphere requiring the use of equipment protection level Ma, the transmitter shall be mounted in an enclosure that provides a degree of protection of at least IP54 according to IEC 60529, and that is suitable for the application and correctly installed. Ambient temperature range: -40°C to +85°C.

Cable entries and blanking elements shall be used that are suitable for the application and correctly installed.

For an ambient temperature ≥ 60°C, heat resistant cables shall be used with a rating of at least 20 K above the ambient temperature.

The sensor circuit is not infallibly galvanically isolated from the input circuit. However, the galvanic isolation between the circuits is capable of withstanding a test voltage of 500 VAC for 1 minute.

IECEx-installation drawing 5331QI02-V2R0

For safe installation of 5331A and 5334A the following must be observed. The module shall only be installed by qualified personnel who are familiar with the national and international laws, directives and standards that apply to this area. Year of manufacture can be taken from the first two digits in the serial number.

Certificate IECEx DEK 20.0059X
 Marking Ex na [c] IIC T6...T4 Gc
 Ex ec [c] IIC T6...T4 Gc
 Ex ic IIC T6...T4 Gc
 Ex ic IIIC Dc
 Standards IEC 60079-0: 2017, IEC 60079-11: 2011, IEC 60079-15: 2010, IEC 60079-7:2017

Terminal 3,4,5,6	Terminal 1,2	Terminal 1,2	Terminal 1,2
Ex ic IIC, Ex ic IIIC	Ex ic IIC, Ex ic IIIC	Ex ic IIC, Ex ic IIIC	Ex na, Ex ec
Uo: 9,6 V Io: 25 mA Po: 60 mW Lc: 33 mH Co: 2,4 µF	Ui = 35 V Ii = 110 mA Ci = 1 nF Li = 10 µH	Ui = 24 V Ii = 260 mA Ci = 1 nF Li = 10 µH	Umax ≤ 35 VDC or Umax ≤ 24 VDC

Ex ic IIC, Ex ic IIIC Temperature Class	Ambient temperature range	
	Ui=35 V	Ui=24 V
T6	-40°C to +54°C	-40°C to +63°C
T5	-40°C to +69°C	-40°C to +78°C
T4	-40°C to +85°C	-40°C to +85°C

Ex ec, Ex na Temperature Class	Ambient temperature range	
	Vmax=35 V	Vmax=24 V
T6	-40°C to +43°C	-40°C to +55°C
T5	-40°C to +85°C	-40°C to +85°C
T4	-40°C to +85°C	-40°C to +85°C

Installation notes

If the enclosure is made of non-metallic plastic materials, electrostatic charges on the transmitter enclosure shall be avoided.

If the transmitter is installed in an explosive atmosphere requiring the use of equipment protection level Gc and applied in type of protection Ex ic, the transmitter shall be mounted in an enclosure that provides a degree of protection of at least IP20 according to IEC 60529, and that is suitable for the application and correctly installed.

If the transmitter is installed in an explosive atmosphere requiring the use of equipment protection level Dc, the transmitter shall be mounted in a separately certified enclosure that provides a degree of protection of at least IP5X according to IEC 60079-0, and that is suitable for the application and correctly installed. The surface temperature of the outer enclosure is +20 K above the ambient temperature, determined without a dust layer. Ambient temperature range: -40°C to +85°C.

If the transmitter is installed in an explosive atmosphere requiring the use of equipment protection level Gc and applied in type of protection Ex na or Ex ec, the transmitter shall be mounted in a separately certified enclosure that provides a degree of protection of at least IP54 according to IEC 60079-0, and that is suitable for the application and correctly installed.

If the transmitter is installed in an explosive atmosphere requiring the use of equipment protection level Gc and applied in type of protection Ex na or Ex ec, the equipment shall only be used in an area of not more than pollution degree 2, as defined in IEC 60664-1.

FM Installation Drawing 5300Q502 V3R0

Model 5331D, 5332D, 5333D and 5343B

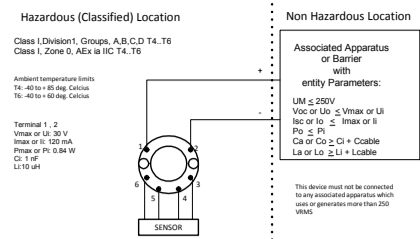

Model 5335D, 5337D

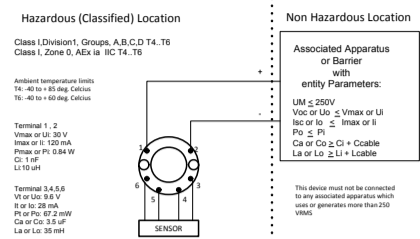

The entity concept

The Transmitter must be installed according to National Electrical Code (ANSI-NFPA 70) and shall be installed with the enclosure, mounting, and spacing segregation requirement of the ultimate application.

Equipment that is FM-approved for intrinsic safety may be connected to barriers based on the ENTITY CONCEPT. This concept permits interconnection of approved transmitters, meters and other devices in combinations which have not been specifically examined by FM, provided that the agency's criteria are met. The combination is then intrinsically safe, if the entity concept is acceptable to the authority having jurisdiction over the installation.

The entity concept criteria are as follows:
 The intrinsically safe devices, other than barriers, must not be a source of power. The maximum voltage $U_i(V_{max})$ and current (I_{max}) , and maximum power $P_i(P_{max})$, which the device can receive and remain intrinsically safe, must be equal to or greater than the voltage $(U_o$ or V_o or V_i) and current $(I_o$ or I_{sc} or $I_i)$ and the power P_o which can be delivered by the barrier.

The sum of the maximum unprotected capacitance (C) for each intrinsically device and the interconnecting wiring must be less than the capacitance (C_a) which can be safely connected to the barrier.

The sum of the maximum unprotected inductance (L) for each intrinsically device and the interconnecting wiring must be less than the inductance (L_a) which can be safely connected to the barrier.

The entity parameters U_o, V_o or V_i and I_o, I_{sc} or I_i , and C_a and L_a for barriers are provided by the barrier manufacturer.

NI Field Circuit Parameters

Model 5331D, 5332D, 5333D, 5335D, 5337D and 5343B

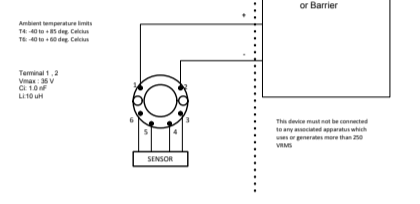

CSA Installation drawing 5333QC03 – V5R0

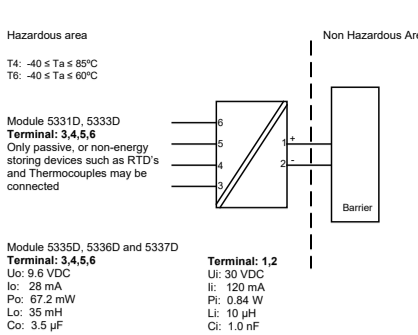

CLASS 2258 84 - PROCESS CONTROL EQUIPMENT - Intrinsically Safe Entry - For Hazardous Locations
CLASS 2258 84 - PROCESS CONTROL EQUIPMENT - Intrinsically Safe Entry - For Hazardous Locations - Certified to US Standards

Class I, Division 1, Groups A, B, C and D T6...T4
 Ex ia IIC T6...T4 Ga
 Class I, Zone 0, AEx ia IIC Ga
Warning:
 Substitution of components may impair intrinsic safety.
 The transmitters must be installed in a suitable enclosure to meet installation codes stipulated in the Canadian Electrical Code (CEC) or for US the National Electrical Code (NEC).

CSA Installation drawing 5333QC02 – V2R0

For safe installation of the 5333A the following must be observed. The module shall only be installed by qualified personnel who are familiar with the national and international laws, directives and standards that apply to this area.

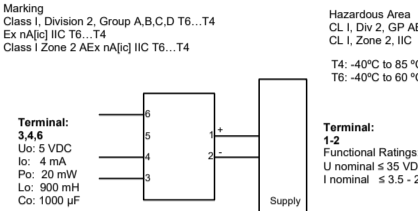

NI Installation instructions

The transmitter must be installed in an enclosure providing a degree of protection of at least IP54 according to IEC60529 that is suitable for the application and is correctly installed. Cable entry devices and blanking elements shall fulfill the same requirements.

If the enclosure is made of non-metallic materials or of painted metal, electrostatic charging shall be avoided. Use supply wires with a rating of at least 5 K above the ambient temperature. Supply from a Class 2 Power Supply with Transient protection or equivalent.

WARNING: Substitution of components may impair suitability for Class I, Division 1, Division 2
AVERTISSEMENT: la substitution de composants peut nuire à l'aptitude à la Classe I, Division 2
WARNING: Do not disconnect equipment unless power has been switched off or the area is known to be safe.
AVERTISSEMENT: Ne débranchez pas l'équipement sauf si l'alimentation a été coupée ou si la zone est connue pour être sûre.

Non Incendive field wiring installation
 The non incendive field wiring circuit concept allows interconnection of Nonincendive Field Wiring Apparatus with Associated Nonincendive Field Wiring Apparatus or Associated Intrinsically Safe Apparatus or Associated Apparatus not specially examined in combination as a system using any of the wiring methods permitted for unclassified locations.
 $V_{oc} < V_{max}$, $C_a > C_i$ or C_{cable} , $L_a > L_i$ or L_{cable} .

Desenho de Instalação INMETRO 5331QB01-V3R0

Para instalação segura do 5331D ou 5334B o seguinte deve ser observado. O modelo deve apenas ser instalado por pessoas qualificadas que são familiarizadas com as leis nacionais e internacionais, diretrizes e padrões que se aplicam a esta área. O ano de fabricação pode ser pegado dos dois primeiros dígitos do número de série.

CertificadoDEKRA 23.0009 XDEKRA 16.0013 X
 Marcas Ex ia IIC T6...T4 Ga
 Ex ia IIIC Db
 Ex ia I Ma
 Normas ABNT NBR IEC 60079-0:2020 Versão Corrigida:2023
 ABNT NBR IEC 60079-11:2013 Versão Corrigida:2017

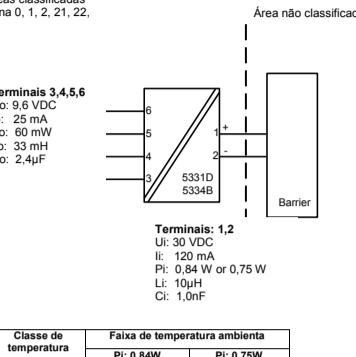

Classe de temperatura	Faixa de temperatura ambiente	
	PI: 0,84W	PI: 0,75W
T6	-40°C to +47°C	-40°C to +50°C
T5	-40°C to +62°C	-40°C to +65°C
T4	-40°C to +85°C	-40°C to +85°C

Notas de instalação

Se o invólucro for feito de materiais plásticos não metálicos, devem ser evitadas cargas eletrostáticas no invólucro do transmissor.

Se o transmissor for instalado em uma atmosfera explosiva que exija o uso de nível de proteção de equipamento Ga, o transmissor deverá ser montado em um invólucro que forneça um grau de proteção de pelo menos IP20 de acordo com a ABNT NBR IEC 60529, e que seja adequado para a aplicação e corretamente instalado.

Se o transmissor for instalado em uma atmosfera explosiva que exija o uso de equipamento de nível de proteção Ga ou Ma, e se o invólucro for feito de alumínio, ele deverá ser instalado de forma que fontes de ignição devido a falhas de impacto e fricção sejam excluídas.

Se o transmissor for instalado em uma atmosfera explosiva que exija o uso de nível de proteção de equipamento Db, o transmissor deverá ser montado em um invólucro certificado separadamente que forneça um grau de proteção de pelo menos IP5X de acordo com a ABNT NBR IEC 60079-0, e que seja adequado para o aplicativo e instalado corretamente. A temperatura da superfície do invólucro externo é +20 K acima da temperatura ambiente, determinada sem camada de poeira. Faixa de temperatura ambiente: -40°C a +85°C.

Se o transmissor for instalado em uma atmosfera explosiva que exija o uso de nível de proteção de equipamento Ma, o transmissor deverá ser montado em um invólucro certificado separadamente que forneça um grau de proteção de pelo menos IP54 de acordo com a ABNT NBR IEC 60529, e que seja adequado para a aplicação e corretamente instalado. Faixa de temperatura ambiente: -40°C a +85°C.

Devem ser utilizadas entradas de cabos e elementos de utilização adequados à aplicação e instalados corretamente.

Para uma temperatura ambiente ≥ 60°C, devem ser utilizados cabos resistentes ao calor com uma classificação de pelo menos 20 K acima da temperatura ambiente.

O circuito do sensor não é infalivelmente galvanicamente isolado do circuito de entrada. Porém, o isolamento galvanico entre os circuitos é capaz de suportar uma tensão de teste de 500VAC por 1 minuto.

Desenho de Instalação INMETRO 5331QB02-V4R0

Para instalação segura do 5331A ou 5334A o seguinte deve ser observado. O modelo deve apenas ser instalado por pessoas qualificadas que são familiarizadas com as leis nacionais e internacionais, diretrizes e padrões que se aplicam a esta área. O ano de fabricação pode ser pegado dos dois primeiros dígitos do número de série.

Certificado DEKRA 23.0009 X
 Marcas Ex ic IIC T4...T6 Gc
 Ex ec IIC T4...T6 Gc
 Ex ic IIIC Dc
 Normas ABNT NBR IEC 60079-0:2020 Versão Corrigida:2023
 ABNT NBR IEC 60079-11:2013 Versão Corrigida:2017
 ABNT NBR IEC 60079-15:2010 Versão Corrigida:2017

Terminal 3,4,5,6	Terminal 1,2	Terminal 1,2	Terminal 1,2
Ex ic IIC, Ex ic IIIC	Ex ic IIC, Ex ic IIIC	Ex ic IIC, Ex ic IIIC	Ex ec
Uo: 9,6 V Io: 25 mA Po: 60 mW Lc: 33 mH Co: 2,4 µF	Ui = 35 V Ii = 110 mA Ci = 1 nF Li = 10 µH	Ui = 24 V Ii = 260 mA Ci = 1 nF Li = 10 µH	Umax ≤ 35 Vdc or Umax ≤ 24 Vdc

Ex ic IIC, Ex ic IIIC Classe de temperatura	Faixa de temperatura ambiente	
	Ui=35V	Ui=24V
T6	-40°C to +54°C	-40°C to +63°C
T5	-40°C to +69°C	-40°C to +78°C
T4	-40°C to +85°C	-40°C to +85°C

Ex ec Temperature Class	Faixa de temperatura ambiente	
	Umax=35V	Umax=24V
T6	-40°C to +43°C	-40°C to +55°C
T5	-40°C to +85°C	-40°C to +85°C
T4	-40°C to +85°C	-40°C to +85°C

Notas para instalação

Se o invólucro for feito de materiais plásticos não metálicos, devem ser evitadas cargas eletrostáticas no invólucro do transmissor.

Se o transmissor for instalado em uma atmosfera explosiva que exija o uso de nível de proteção de equipamento Gc e aplicado no tipo de proteção Ex ic, o transmissor deverá ser montado em um gabinete que forneça um grau de proteção de pelo menos IP20 de acordo com a ABNT NBR IEC 60529, e adequado à aplicação e instalado corretamente.